

TRIBE 2 Side Table

DESIGN BY OKHA

twentieth

sales@twentieth.net 323.904.1200 www.twentieth.net

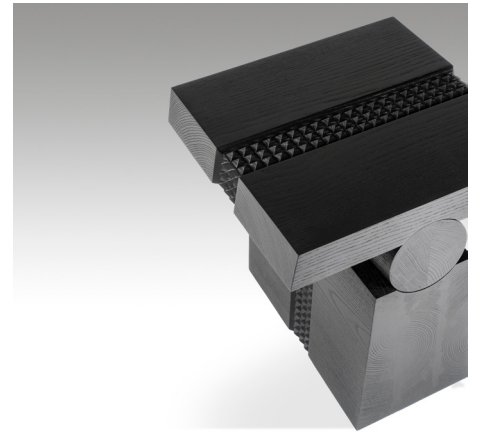
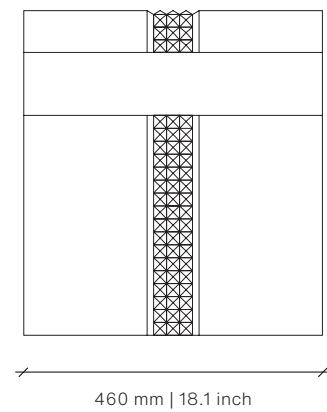
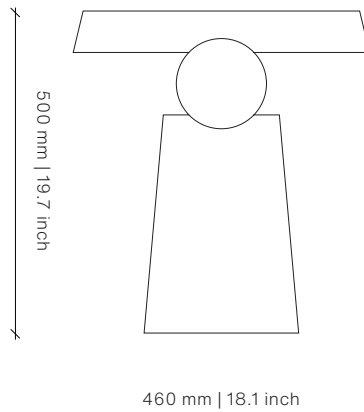
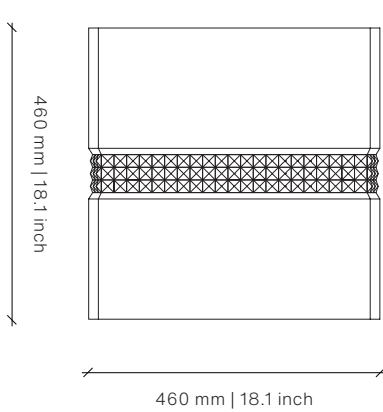
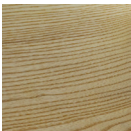

Image shows standard version in Carbon Ash



Indoor



Natural Ash

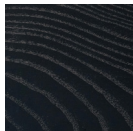

Carbon Ash



Dark Java
Ash

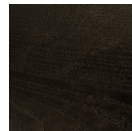

Mocca Ash

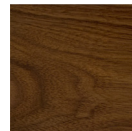

French Oak

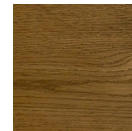

Black Washed
French Oak

Outdoor

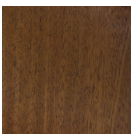

Oiled Iroko

Dimensions (mm)

460W x 460D x 500H

Dimensions (inches)

18.1W x 18.1D x 19.7H

Different textures, grains, colouration and densities are all natural characteristics of timbers. We find these variances an inherent and valuable part of the natural beauty of wood, no two pieces are the same making each OKHA design a unique, characterful piece and each product will be different from the next. Timber movement will also occur as this is a natural product.

STONE: Marble is a beautiful natural material with inherent imperfections in its structure, veining and coloration. As such, some slabs may be reinforced with meshing on the underside and may have colour matched resin fills in minor cracks and surface blemishes. Please note that this is standard practice.

METAL: All metals will go through a process of natural aging and oxidization due to environmental conditions. The result of this aging process will bring about colour change, to slow and reduce this natural process, appropriate cleaning and maintenance products can be used.

OKHA