

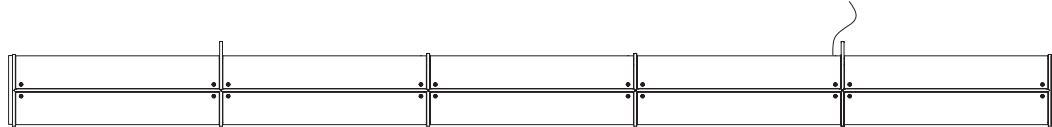





CONTENTS

Woody Endless 5

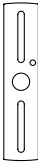
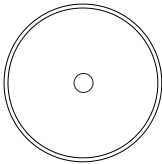

<p>Nipple (2)</p> 	<p>8-32 Screw (2)</p> 	<p>Hangstraight (2)</p> 	<p>Stem (2)</p> 
<p>Crossbar (2)</p> 	<p>Canopy (2)</p> 	<p>Hook (2)</p>  <p>Wago Connector (5)</p> 	

SAFETY INFORMATION

Only suitable for direct mounting on non-combustible surfaces.
Under no circumstances can Endless be mounted on normally flammable surfaces.
Suitable for dry, indoor use only.
Maximum ambient temperatures: 25° C

ENDLESS 3 AND 5 | PREPARING CEILING INSTALLATION

Note: Please contact a licensed electrician.

01. Endless fixtures with 1-9 units will be configured by Roll & Hill to have either 2 or 3 hanging points. Segments with hanging points can be clearly identified by their teardrop shaped hardware. Each unit is exactly 18" long.

Standard hanging point spacing:

Endless 3: 18"



Endless 5: 54"



02. One hanging point, referred to from here forward as the 'primary hanging point' requires connection to a junction box. Junction boxes are to be placed on center of the designated hanging point. The primary hanging point is the only hanging point with an associated power cable.

Additional hanging points, from here forward referred to as 'secondary hanging points' can be mounted to a junction box, or simply to the finished ceiling if it is able to anchor into a structural member. For safety, all hanging points, junction box or finished ceiling points must be able to support 50 pounds of dead weight.

ENDLESS 3 AND 5 | PREPARING CEILING INSTALLATION

Standard 3 unit configuration with hanging points separated by 1 unit:

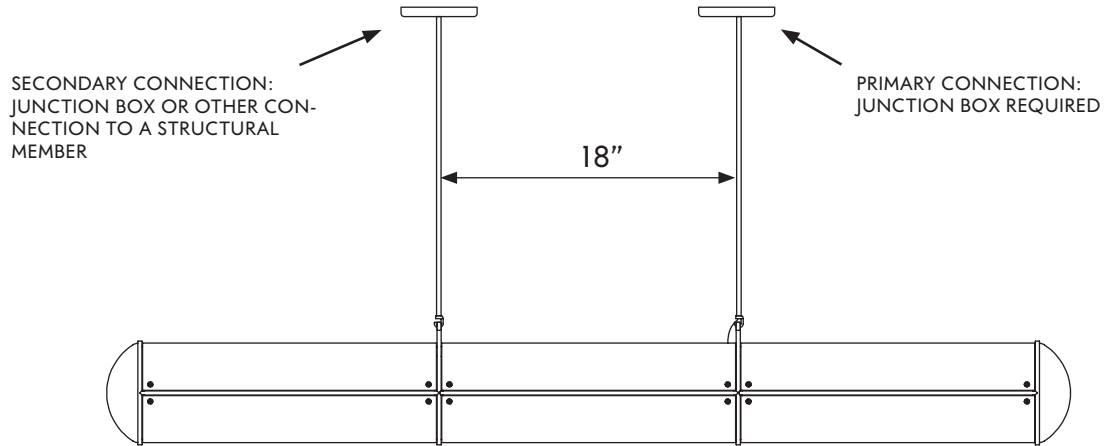

Standard 5 unit configuration with hanging points separated by 3 units:

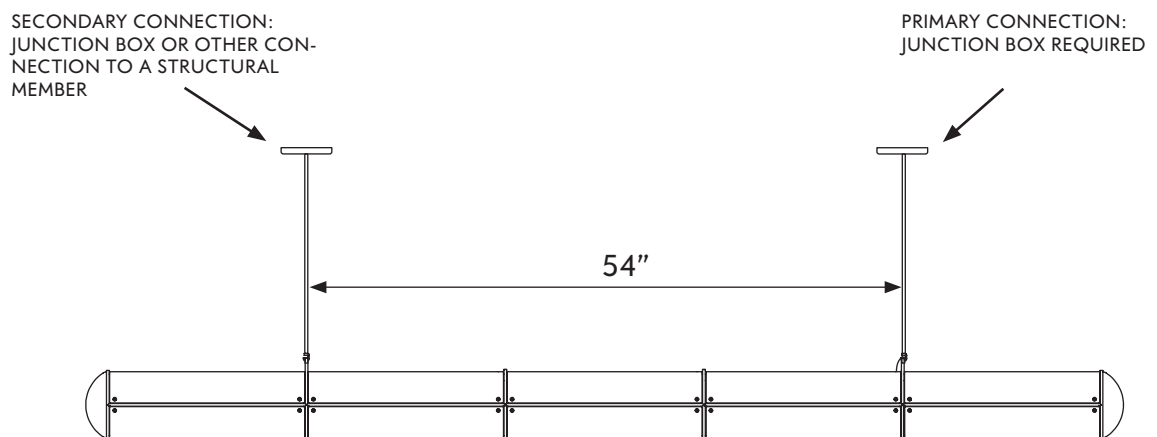

ENDLESS 3 AND 5 | INSTALLING CEILING HARDWARE

Note: Each Endless unit has 1 primary hanging point requiring a junction box where electrical connections are made, and 1 or more secondary hanging points. Please review both connection types before installing ceiling hardware.

01. For the primary hanging point, install crossbar (A) using 8-32 screws to junction box (B).
It is recommended to pull the mains wire out so they are accessible while making the main connection later.
02. Install the hanging stem (D) with the hangstraight body (E) and 1/4 IPS nipple into the crossbar.
Note that the hangstraight nut and canopy are not attached at this point and hang below the junction box connection. This will allow you to make the lead connections.
03. Connect the lead wires from the fixture to the lead wires from the ceiling using the provided wago connectors (H), Connect the ground wires with the provided wago connector (C).
Optional: 0-10V dimming wires, purple and gray (J) (be sure to use a cap/wago on wires if not in use, crossing these wires could turn off the light). Tuck all the wires back into the junction box.
04. Raise the canopy (F) and hangstraight nut (G).
Thread the nut on, pushing the canopy flush to the ceiling.

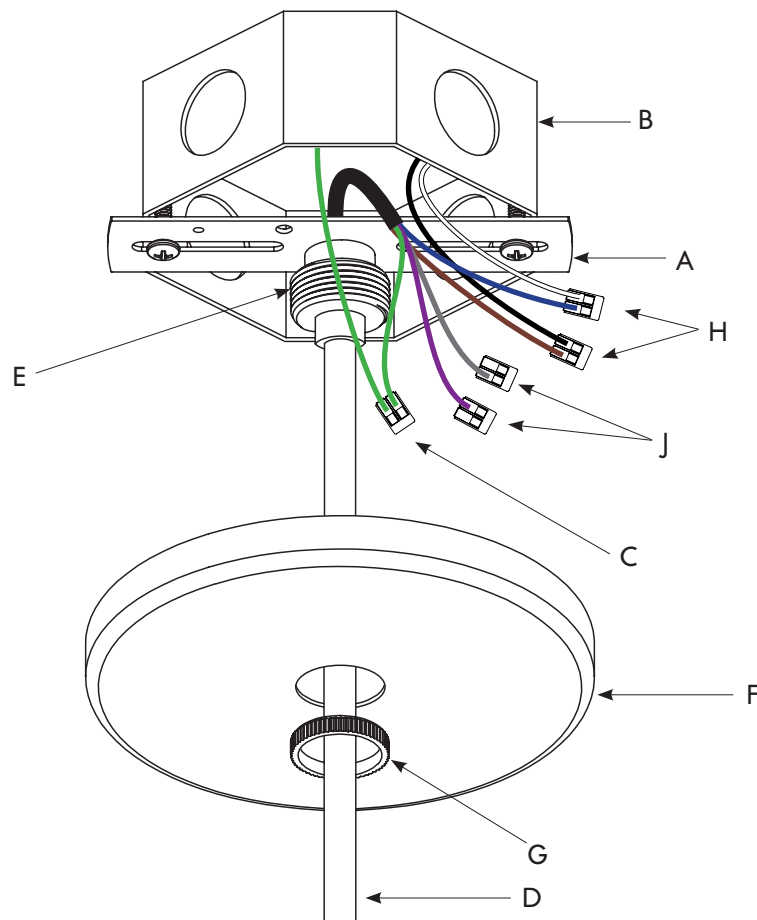

ENDLESS 3 AND 5 INSTALLATION | INSTALLING CEILING HARDWARE

05. Install secondary hanging point anchor or crossbar. Secondary hanging points do not require junction boxes. If a connection to a junction box is made, repeat steps 1-3. It is recommended to use the ground strap using the green #8 screw and a wire nut. If a junction box is not installed, the crossbar can be installed into a structural member able to support a minimum of 50 pounds. The 8-32 screws may need to be replaced with other appropriate fasteners such as wood or concrete screws. Fasteners must be able to support 50 pounds when installed.
06. There will be no lead to feed through the secondary hanging stem. Simply attach the hook onto the hanging plate.

HANGING FIXTURE TO HARDWARE

01. Lift the Endless fixture into place under the installed hanging points. This will require a minimum of two people. It is recommended to leave the protective foam in place to reduce the risk of damage to the fixtures surface. Attach the hooks onto the hanging plates and make sure they are secured. The black lead wire will need to be fed through the primary hanging stem up to the junction box.
02. Ensure the hooks are properly engaged by applying gentle pressure.

