

## CONTENTS

---

Halo Rectangle

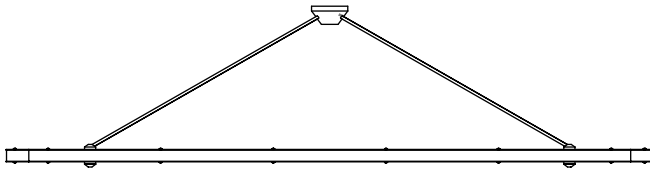

Stem and 1/8 IPS  
Threaded Rod



Canopy  
Assembly

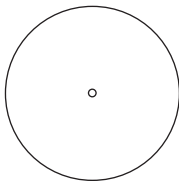

Crossbar Assembly

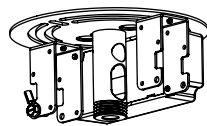

Canopy Nut



8-32 Crossbar Screws (2)



Wire Connectors (5)



## SAFETY INFORMATION

---

Only suitable for direct mounting on non-combustible surfaces.  
Under no circumstances can Halo Chandeliers be mounted on normally flammable surfaces.  
Suitable for dry, indoor use only.  
Maximum ambient temperatures: 25° C

## Stem and cover tube length adjustment

*Note: Please contact a licensed electrician.*

### Example fixture only:

To measure length of stem, first determine overall length (OAL), subtract 1" for the canopy height and subtract the fixture height from the OAL. Fixture height is measured from bottom of the fixture to stem connection point.

The resulting measurement is the final stem length.

Ex. The fixture below has an OAL of 30" and a fixture height of 12".

$$30'' \text{ OAL} - 2'' \text{ canopy} - 14.5'' \text{ fixture height} = 13.5'' \text{ stem}$$

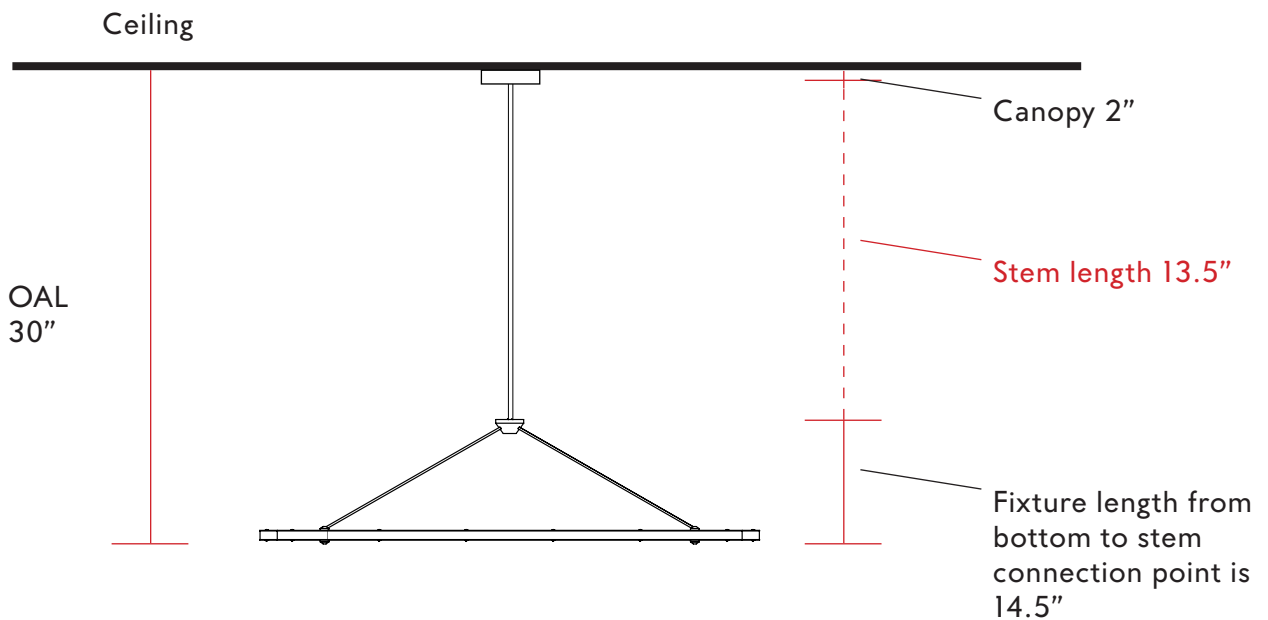

## Stem and cover tube length adjustment

*Note: Please contact a licensed electrician.*

### Example fixture only:

1. To customize the length of the provided stem, cut cover tube to desired length. Then cut the inner threaded tube so that it remains .5" longer than the cover tube.

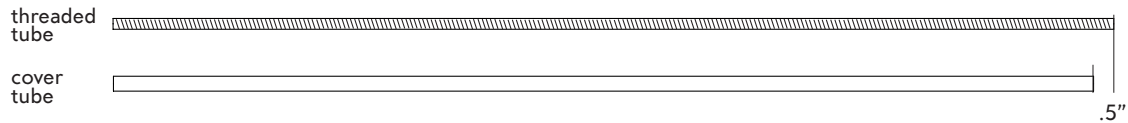

2. Mark the length of the tube required, using a marker or tape. Then hold down the tube with a hand or a clamp, use a hacksaw or electrical tool to cut the tube. Recommended to clean tube after cutting to remove any metal chippings.

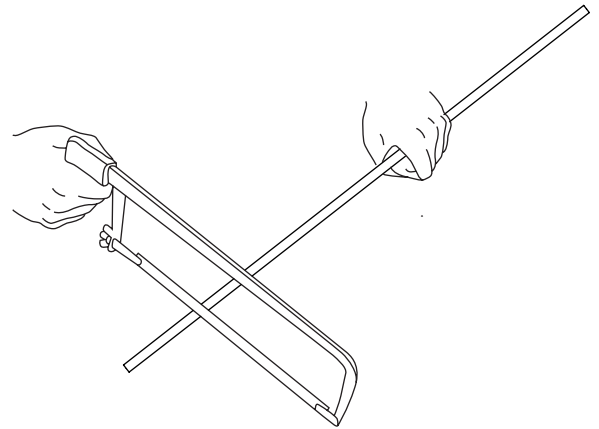

3. Now that the cover tube is cut to 13.5", measure the all thread tube to be 14" long. And place a mark, with a marker or tape.

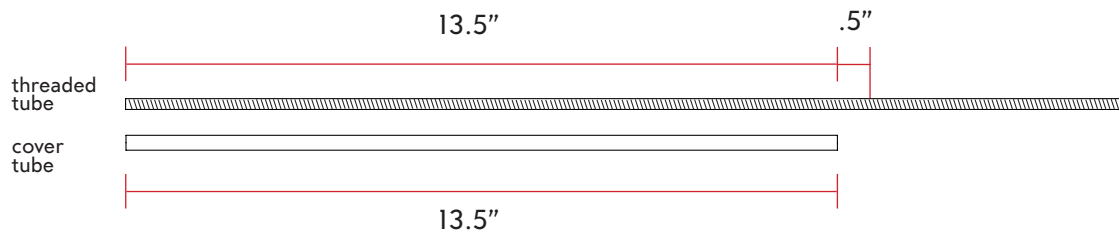

4. Hold down the all thread with a hand or a clamp, use a hacksaw or electrical tool to cut the all thread tube. Recommended to clean all thread tube after cutting to remove any metal chippings.

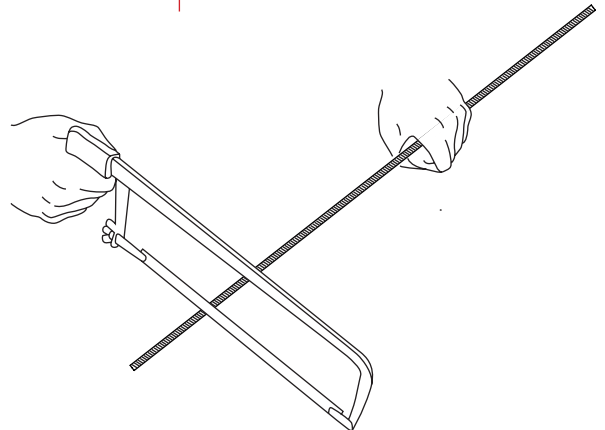

## HALO | CEILING INSTALLATION

*Note: Please contact a licensed electrician.*

1. Install the crossbar assembly using #8-32 screws to junction box (C) in ceiling. Pull the lead wires through the center hole in order to make lead connections.
2. Attach the green ground wire to the crossbar with ground screw (D).
3. Make wire connections between junction box leads and the LED driver (E).
4. Slide hangstraight nut (F) and canopy (G) down cover tube and screw inner threaded tube into hangstraight (H).
5. Feed fixture lead wires from the driver assembly down through the cover tube (I).
6. Raise canopy and hangstraight nut to ceiling and tighten nut around hangstraight. This will tighten canopy flush to ceiling. Make sure to conceal wires and connections inside canopy.

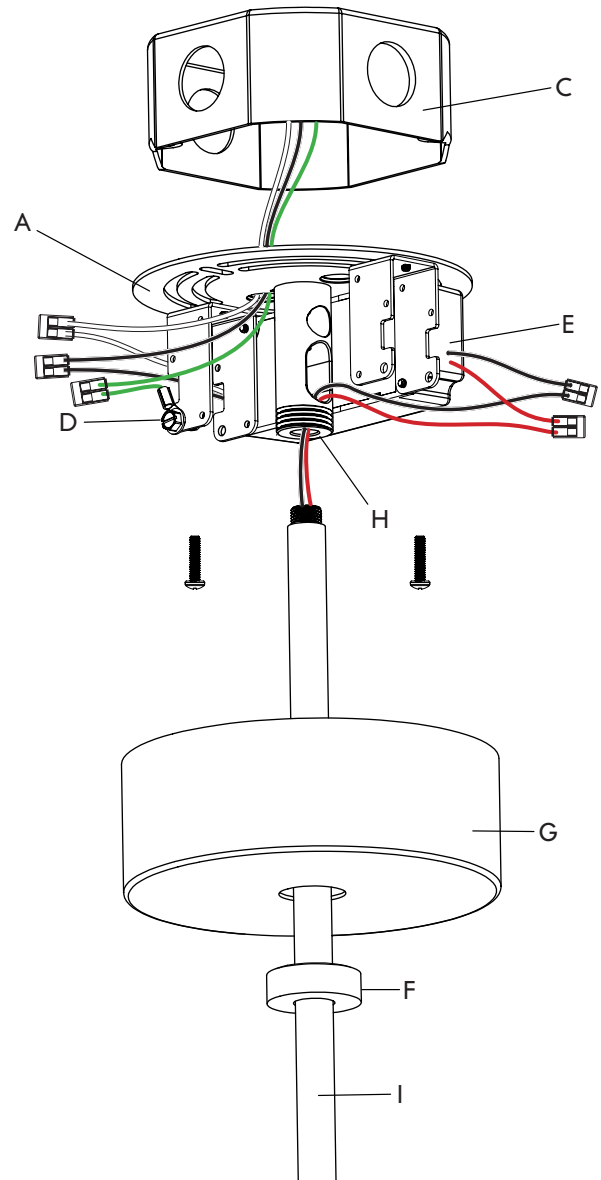

## HALO | CEILING INSTALLATION

---

*Note: This step requires two people.*

7. Separate hub (G) and hub cap (H) by removing five machine screws. Run wires through threaded stem and cover tube and attach to canopy.
8. Carefully lift the fixture so that the hub and cap align. Cut excess wire, strip ends, and make electrical connections between the stem and the fixture. Tuck wire nuts and wires inside the hub and close.
9. Secure the plate and hub back together using same five machine screws.

