

CONTENTS

Knotty Bubbles Chandelier
 3 Large, 2 Small, 5 Barnacles

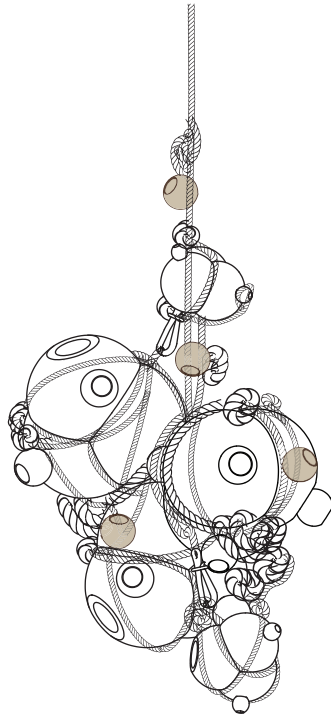

Canopy

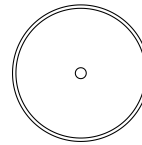

Screw Collar



Crossbar

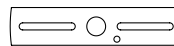

S Hook



8-32 Crossbar
 Screws (2)



1/4 IPS Nipple



Bulbs



Incandescent 120V (bulbs included)
 Incandescent 240V (bulbs not included)



Halogen 120V (bulbs included)
 Halogen 240V (bulbs not included)

Transformer (For halogen fixtures only)

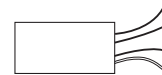

SAFETY INFORMATION

Only one light bulb per socket.

Only suitable for direct mounting on non-combustible surfaces.

Under no circumstances can Knotty Bubbles be mounted on normally flammable surfaces.

Suitable for dry, indoor use only. Maximum ambient temperatures: 25° C

If the external flexible cable or cord of this luminaire is damaged, it shall be exclusively replaced by Roll & Hill's service agent or a similarly qualified person in order to avoid hazard.

KNOTTY BUBBLES | CEILING INSTALLATION

*Note: Please contact a licensed electrician.
 Note: Do not use bulbs that exceed 25 watts.*

1. Install the crossbar (A) using #8-32 screws to junction box (B). It is recommended to pull the main wires out so they are accessible while making the main connection later (C).
2. Once the crossbar is secure, attach the ground wire to the green ground screw (D).
3. Screw the 1/4 IPS nipple into the hangstraight (E) and then into the crossbar.

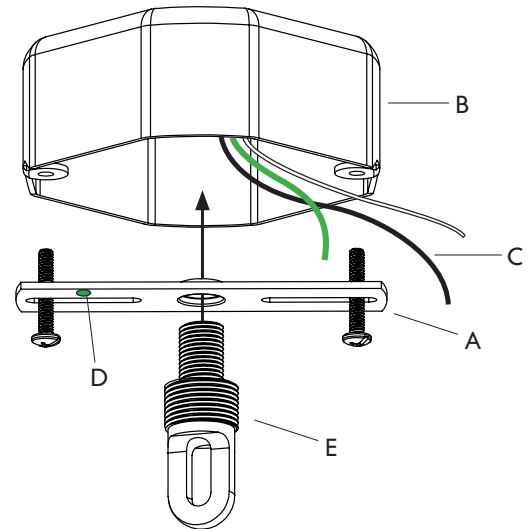

4. Unscrew the hangstraight nut (F) from the hangstraight. Feed onto wire from fixture, followed by the canopy. Carefully raise fixture to ceiling and hold, while guiding the lead wire through the hangstraight into the junction box.
5. Crimp the C-shaped strain relief around the lead wire just above the crossbar. Strip wires and make connections to the leads in the ceiling (G) with provided wire nuts.

For Halogen fixtures, first make connections to the transformer, and then from the transformer to the ceiling lead wires.

6. Tuck the connected wires into the junction box and raise the canopy and hangstraight nut. Thread the nut onto the hangstraight, tightening the canopy flush to the ceiling.

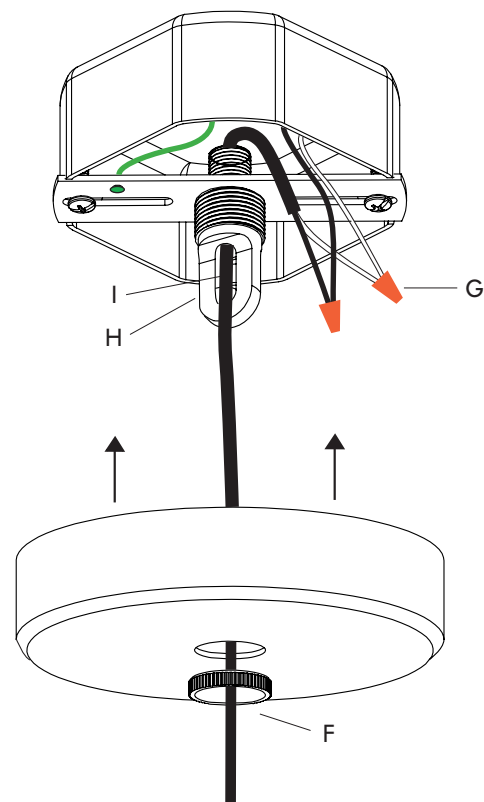

KNOTTY BUBBLES | CEILING INSTALLATION

7. Hook the S-hook (H) onto the hang-straight loop. Loop the knotted rope (I) over the S-hook to support weight of fixture.

8. Install bulbs into each bubble by carefully pushing into sockets.

9. Carefully remove the remaining packing material from the chandelier.

