



GABRIEL SCOTT

EST. 2012



**Welles by
Kelly Hoppen CBE**

Long Chandelier 24

in Satin Brass & Matte White Clay



Crafted from white clay and complemented by satin brass, Kelly's reinterpretation is inspired by a collection of ceramics that she is currently designing. Kelly has focused on the materials and scaled the size down to create an elegant overall appearance. It is wonderfully delicate yet maintains the same sense of movement as the original Welles fixture.

The overall form has been scaled down from its original size to create an elegantly delicate aesthetic. The Welles Long Chandelier 24 by Kelly Hoppen contrasts this small scale with the enhanced length of the fixture. Kelly Hoppen's capsule collection comprises of three different sizes of Long Chandelier, a Pendant light, a Single Sconce suitable for both wall and ceiling installation and an Arm Sconce.

twentieth

sales@twentieth.net
323.904.1200
www.twentieth.net

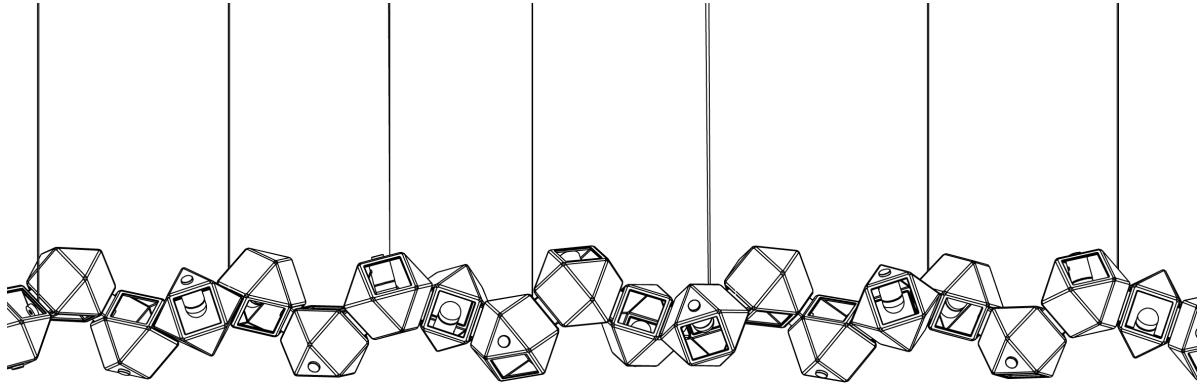

81.43" / 206.8cm

SPECIFICATIONS

Standard Finishes:

Clay: Matte White

Metal: Blackened Steel, Satin Nickel,
Satin Brass, Satin Copper or Satin Bronze

Specifications:

Dimensions: 81.43" x 7.23" x 6.66" H + Drop

206.8 cm x 18.4 cm x 17 cm H + Drop

Weight: 18 lbs / 8.2 kg

Light Source: 12V 3 Watt LED (included)

LED Drivers: E60L12DC-KO - 110V
UVC1250TD - 220V

Total Wattage (nominal): 40.8 w
Lumens (total): 8160 lm

Cables & Canopies:

Cable Length: 96" / 244 cm Drop
Adjustable upon installation

(increased cable-lengths available upon request)

Standard Canopy: 5" x 0.5" / 12 cm x 1.3 cm

Deep Canopy: Available upon request.

Custom finishes available upon inquiry.

Made and assembled in Canada.

STANDARD FINISHES

Clay:



Matte White

Metal:

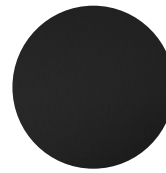

Blackened Steel

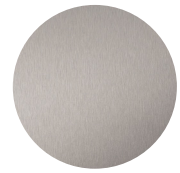

Satin Nickel



Satin Brass



Satin Copper



Satin Bronze

twentieth

sales@twentieth.net
323.904.1200
www.twentieth.net

LED DRIVER

E60L12DC-KO - 110V

Magnitude's E60L12DC-KO dimmable voltage LED driver is class 2 rated and designed to operate with any standard MLV/ Incandescent TRIAC (Leading edge) dimmer switch. Encased in a low profile aluminum enclosure that includes 2 knock-outs to enable easy installation makes it the perfect choice for under cabinet lights, tape lights and various LED fixtures installations. Our electrical specification includes Auto Reset, over current and short circuit protection. Efficiency of 90% and higher allows the driver to operate at low temperatures.

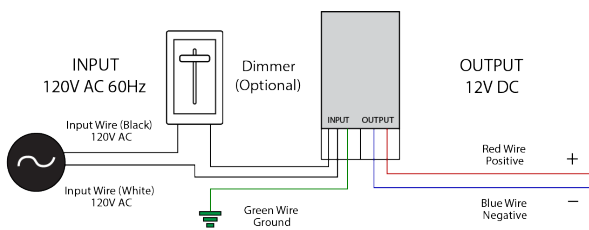
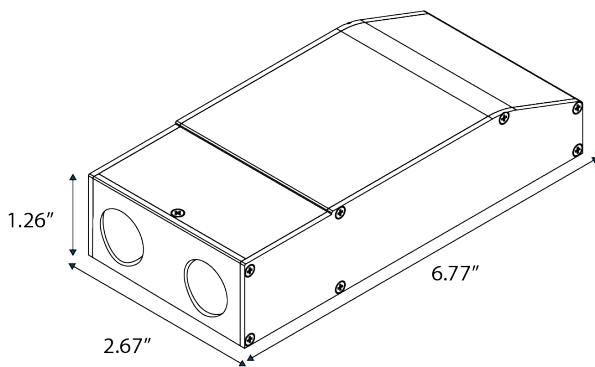

Features:

- Dimmable with any standard MLV/Incandescent TRI-AC- (Leading edge) dimmer switch.
- Super compact ALUMINUM CASE.
- Class 2
- UL 8750
- IP67 - Withstands wet and salty conditions.
- Nema 3R - Outdoor Use
- Auto-Reset Protection for short circuits & over-voltage.
- FCC 15 part 2
- 12V DC True RMS

Specifications:

Max Load	60W
Input Voltage	120V AC
Input Current at Max Load	0.61 A
Output Voltage	12V DC
Output Current at Max load	5.26 A
Power Factor	0.95
Efficiency	> 90 %
Operating Temp.	-20c - 70c (-4F -158F)
Short Circuit Protection	Yes
Overcurrent Protection	Yes
Over Temperature	Yes
Open Circuit Protections	Yes
Input Wires (White / Black)	14 AWG
Output Wires (Red / Black)	18 AWG
Weight	481g
Dimensions (inches)	6.77" x 2.67" x 1.26"
Dimensions (cm)	17.2 cm x 6.8 cm x 3.2 cm

twentieth

sales@twentieth.net
323.904.1200
www.twentieth.net

LED DRIVER

UVC1250TD - 220V

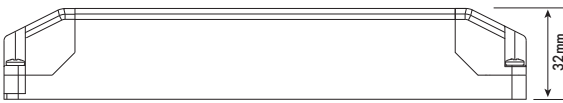
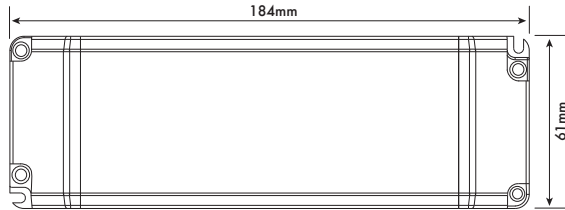

Features:

- Constant voltage output
- Fully isolated
- Short circuit, over current and over voltage protection up to 80% efficient.
- Fire resistant plastic cover
- Compatible with leading and trailing edge dimmers
- 20 - 100% Dimming Load and Dimming range
- Mains dimmable
- Screw terminals
- IP44 design for indoor use
- 2 years warranty

Specifications:

Part Code	UVC1250TD UVC2450TD
Voltage	220V ~ 240VAC
Frequency	50-60 Hz
Current	0.4A
Inrush Current	<2.5A
Power Factor	0.95
Load Voltage	12V
No Load Voltage	12V
Current	4.16A
Power	50W
Power Factor	>0.95
Efficiency (TYP)	>80%
Over Load	Auto-recovery
Short Circuit	Auto-recovery
Over Voltage	Auto-recovery
Operating Temperature	-20 ~ +50°C
Storage Temperature	-40 ~ +70°C
Relative Humidity	5 ~ 95%
Lifetime	50K hrs at TC max (85°C)
Connections	Screw terminal on I/P & O/P
Weight	200g
Dimensions (inches)	7.2" x 2.4" x 1.25"
Dimensions (cm)	18.4 cm x 6 cm x 3.2 cm

twentieth

sales@twentieth.net
323.904.1200
www.twentieth.net