

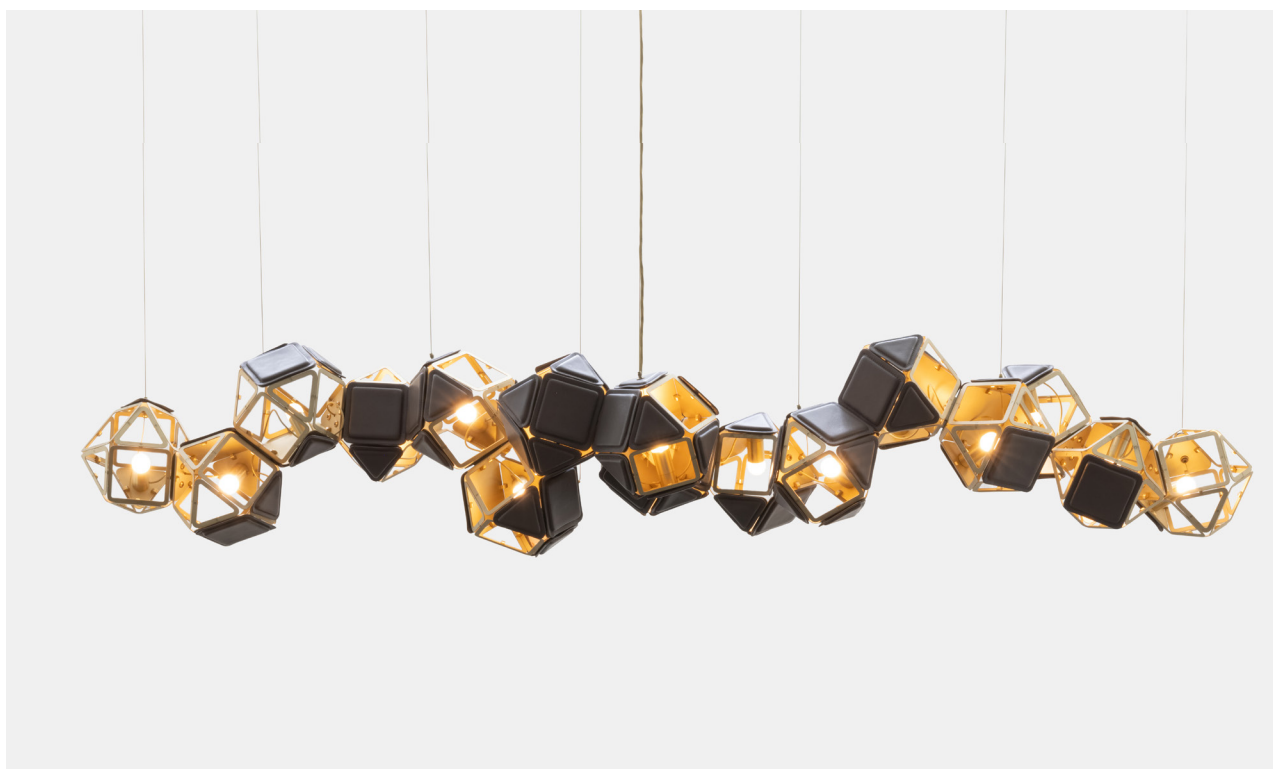

GABRIEL SCOTT

EST. 2012



**Welles by  
Sybille de Margerie**  
Long Chandelier 16

in Satin Brass & Sparrow  
Brown Leather



SYBILLE DE MARGERIE  
PARIS

As a contrast to the original Welles sharp metal and glass silhouette, Sybille de Margerie has created a new interpretation revealing the feminine side of her signature design style. Couture-inspired, her Welles Reimagined capsule collection shows a gradient composition from emptiness to fullness, with a variation of hollow and plain shapes.

Fully customizable, Sybille has used soft, rounded moveable padded magnetic leather panels to create a subtle 3D effect, thus creating new light effects and shadow. The Welles Long Chandelier 16 by Sybille de Margerie floats effortlessly, adding a sense of movement and dimension to any space. The capsule collection comprises a Long, Central and Vertical Chandelier, as well as a Triple Pendant and Single Sconce.

twentieth

sales@twentieth.net  
323.904.1200  
www.twentieth.net

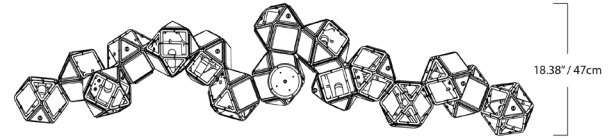
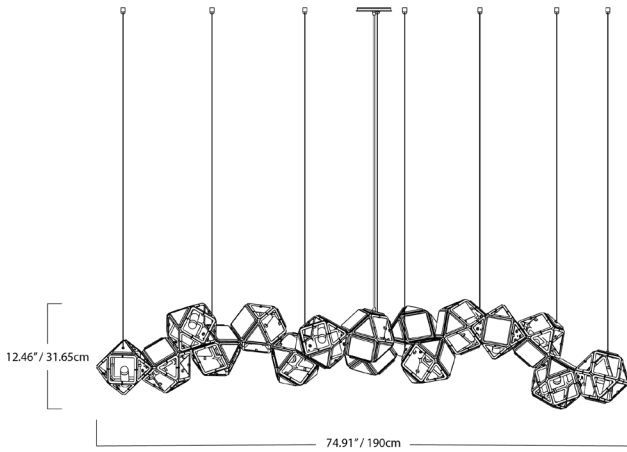

## SPECIFICATIONS

### Standard Finishes:

Vegan Leather: Sparrow Brown, Nude, Gray, Navy or Black

Metal: Blackened Steel, Satin Nickel, Satin Brass, Satin Copper or Satin Bronze

### Specifications:

Dimensions: 74.91" x 18.38" x 12.46" H + Drop

190 cm x 47 cm x 32 cm H + Drop

Weight: 37.8 lbs / 17.2 kg

Light Source: 12V 6 Watt LED (included)

LED Drivers: E60L12DC-KO - 110V  
UVC1250TD - 220V

Total Wattage (nominal): 49.6 w  
Lumens (total): 10880 lm

### Cables & Canopies:

Cable Length: 96" / 244 cm Drop  
Adjustable upon installation

(increased cable-lengths available upon request)

Standard Canopy: 5" x 0.5" / 12 cm x 1.3 cm

Deep Canopy: Available upon request.

## STANDARD FINISHES

### Vegan Leather:

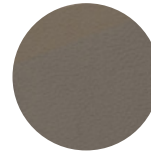

Sparrow Brown -  
Vegan Leather

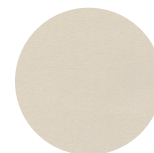

Nude - Vegan  
Leather

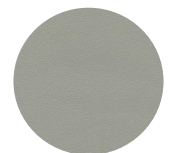

Gray - Vegan  
Leather



Navy - Vegan  
Leather

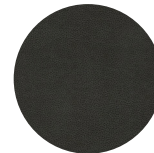

Black - Vegan  
Leather

### Metal:

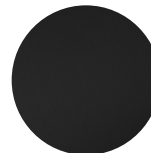

Blackened Steel

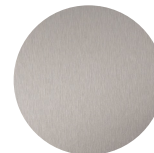

Satin Nickel



Satin Brass



Satin Copper



Satin Bronze

twentieth

sales@twentieth.net  
323.904.1200  
www.twentieth.net

# LED DRIVER

E60L12DC-KO - 110V

Magnitude's E60L12DC-KO dimmable voltage LED driver is class 2 rated and designed to operate with any standard MLV/ Incandescent TRIAC (Leading edge) dimmer switch. Encased in a low profile aluminum enclosure that includes 2 knock-outs to enable easy installation makes it the perfect choice for under cabinet lights, tape lights and various LED fixtures installations. Our electrical specification includes Auto Reset, over current and short circuit protection. Efficiency of 90% and higher allows the driver to operate at low temperatures.

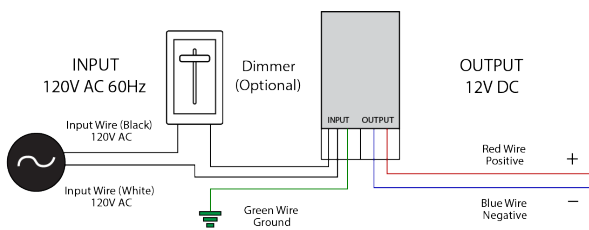
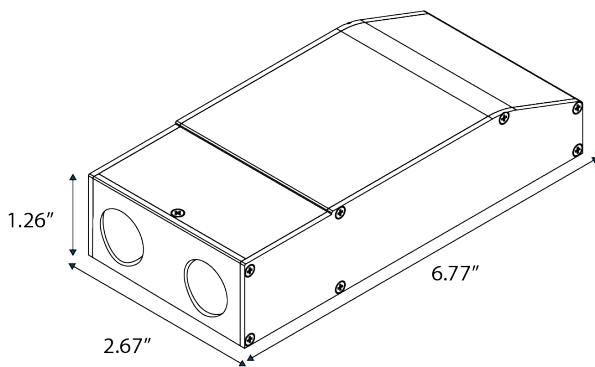

## Features:

- Dimmable with any standard MLV/Incandescent TRI-AC- (Leading edge) dimmer switch.
- Super compact ALUMINUM CASE.
- Class 2
- UL 8750
- IP67 - Withstands wet and salty conditions.
- Nema 3R - Outdoor Use
- Auto-Reset Protection for short circuits & over-voltage.
- FCC 15 part 2
- 12V DC True RMS

## Specifications:

Max Load	60W
Input Voltage	120V AC
Input Current at Max Load	0.61 A
Output Voltage	12V DC
Output Current at Max load	5.26 A
Power Factor	0.95
Efficiency	> 90 %
Operating Temp.	-20c - 70c (-4F -158F)
Short Circuit Protection	Yes
Overcurrent Protection	Yes
Over Temperature	Yes
Open Circuit Protections	Yes
Input Wires (White / Black)	14 AWG
Output Wires (Red / Black)	18 AWG
Weight	481g
Dimensions (inches)	6.77" x 2.67" x 1.26"
Dimensions (cm)	17.2 cm x 6.8 cm x 3.2 cm

twentieth

sales@twentieth.net  
323.904.1200  
www.twentieth.net

# LED DRIVER

UVC1250TD - 220V

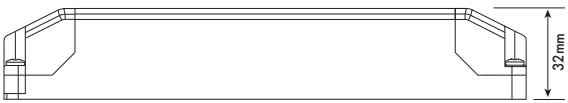
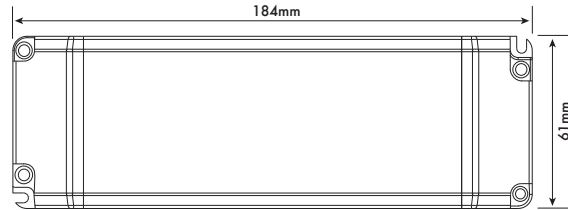

## Features:

- Constant voltage output
- Fully isolated
- Short circuit, over current and over voltage protection up to 80% efficient.
- Fire resistant plastic cover
- Compatible with leading and trailing edge dimmers
- 20 - 100% Dimming Load and Dimming range
- Mains dimmable
- Screw terminals
- IP44 design for indoor use
- 2 years warranty

## Specifications:

Part Code	UVC1250TD UVC2450TD
Voltage	220V ~ 240VAC
Frequency	50-60 Hz
Current	0.4A
Inrush Current	<2.5A
Power Factor	0.95
Load Voltage	12V
No Load Voltage	12V
Current	4.16A
Power	50W
Power Factor	>0.95
Efficiency (TYP)	>80%
Over Load	Auto-recovery
Short Circuit	Auto-recovery
Over Voltage	Auto-recovery
Operating Temperature	-20 ~ +50°C
Storage Temperature	-40 ~ +70°C
Relative Humidity	5 ~ 95%
Lifetime	50K hrs at TC max (85°C)
Connections	Screw terminal on I/P & O/P
Weight	200g
Dimensions (inches)	7.2" x 2.4" x 1.25"
Dimensions (cm)	18.4 cm x 6 cm x 3.2 cm

twentieth

sales@twentieth.net  
323.904.1200  
www.twentieth.net