



GABRIEL SCOTT

EST. 2012



WELLES
Glass Long
Chandelier 14
in Satin Brass &
Alabaster White

A new type of modular elegance, the Welles bridges feminine and masculine sensibilities for a perfect blend of strength and sophistication.

Each one of a kind glass piece is mold-blown to generate a gem like form and create a bright diffused light. Polished prong-like hardware boldly supports each glass volume and holds the body of the overall organic silhouette.

All Gabriel Scott pieces are handmade in Canada.

twentieth

sales@twentieth.net
323.904.1200
www.twentieth.net

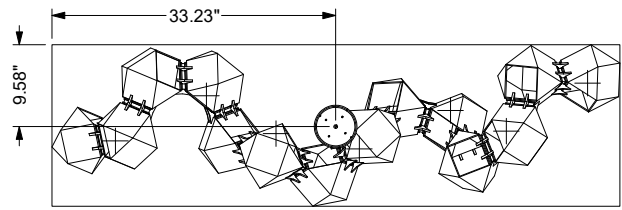
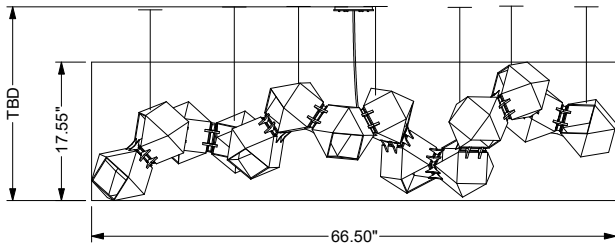

SPECIFICATIONS

Standard Finishes:

Glass: Alabaster White or Smoked Gray

Metal: Satin Nickel, Satin Copper, Satin Brass,
Satin Bronze or Blackened Steel

Specifications:

Dimensions: 66.5" x 18.9" x 17.55" H + Drop

169 cm x 48 cm x 45 cm H + Drop

Weight: 5 lbs / 2.27 kg per cube

Light Source: 12V 6 Watt LED (included)

LED Drivers: E60L12DC-KO - 110V
UVC1250TD - 220V

Total Wattage (nominal): 43.4 w
Lumens (total): 9520 lm

Cables & Canopies:

Cable Length: 96" / 244 cm Drop, adjustable upon installation

(increased cable-lengths available upon request)

Standard Canopy: 5" x 0.5" / 12 cm x 1.3 cm

Deep Canopy: Available upon request.

Custom finishes available upon inquiry.

Made and assembled in Canada. Item is UL & CE listed.



STANDARD FINISHES



Alabaster White
& Satin Nickel

Alabaster White
& Satin Copper

Alabaster White
& Satin Brass



Alabaster White
& Satin Bronze

Alabaster White
& Blackened Steel



Smoked Gray
& Satin Nickel

Smoked Gray
& Satin Copper

Smoked Gray
& Satin Brass



Smoked Gray &
Satin Bronze

Smoked Gray &
Blackened Steel

twentieth

sales@twentieth.net
323.904.1200
www.twentieth.net

LED DRIVER

E60L12DC-KO - 110V

Magnitude's E60L12DC-KO dimmable voltage LED driver is class 2 rated and designed to operate with any standard MLV/ Incandescent TRIAC (Leading edge) dimmer switch. Encased in a low profile aluminum enclosure that includes 2 knock-outs to enable easy installation makes it the perfect choice for under cabinet lights, tape lights and various LED fixtures installations. Our electrical specification includes Auto Reset, over current and short circuit protection. Efficiency of 90% and higher allows the driver to operate at low temperatures.

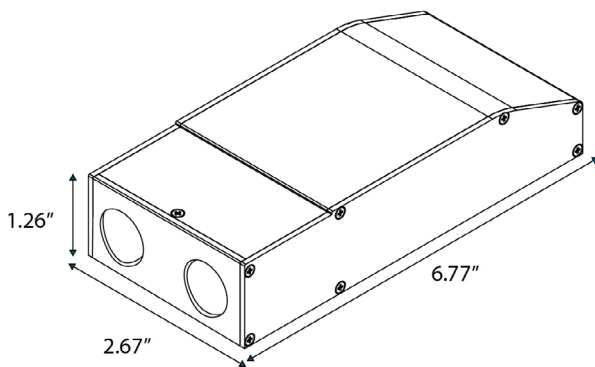

Features:

- Dimmable with any standard MLV/Incandescent TRI-AC- (Leading edge) dimmer switch.
- Super compact ALUMINUM CASE.
- Class 2
- UL 8750
- IP67 - Withstands wet and salty conditions.
- Nema 3R - Outdoor Use
- Auto-Reset Protection for short circuits & over-voltage.
- FCC 15 part 2
- 12V DC True RMS

Specifications:

Max Load	60W
Input Voltage	120V AC
Input Current at Max Load	0.61 A
Output Voltage	12V DC
Output Current at Max load	5.26 A
Power Factor	0.95
Efficiency	> 90 %
Operating Temp.	-20c - 70c (-4F -158F)
Short Circuit Protection	Yes
Overcurrent Protection	Yes
Over Temperature	Yes
Open Circuit Protections	Yes
Input Wires (White / Black)	14 AWG
Output Wires (Red / Black)	18 AWG
Weight	481g
Dimensions (inches)	6.77" x 2.67" x 1.26"
Dimensions (cm)	17.2 cm x 6.8 cm x 3.2 cm

twentieth

sales@twentieth.net
323.904.1200
www.twentieth.net

LED DRIVER

UVC1250TD - 220V

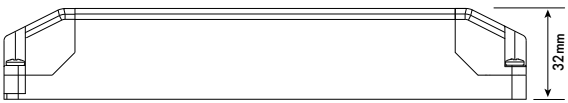
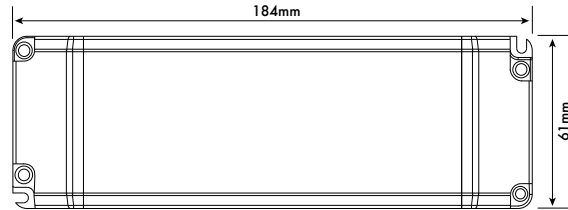

Features:

- Constant voltage output
- Fully isolated
- Short circuit, over current and over voltage protection up to 80% efficient.
- Fire resistant plastic cover
- Compatible with leading and trailing edge dimmers
- 20 - 100% Dimming Load and Dimming range
- Mains dimmable
- Screw terminals
- IP44 design for indoor use
- 2 years warranty

Specifications:

Part Code	UVC1250TD UVC2450TD
Voltage	220V ~ 240VAC
Frequency	50-60 Hz
Current	0.4A
Inrush Current	<2.5A
Power Factor	0.95
Load Voltage	12V
No Load Voltage	12V
Current	4.16A
Power	50W
Power Factor	>0.95
Efficiency (TYP)	>80%
Over Load	Auto-recovery
Short Circuit	Auto-recovery
Over Voltage	Auto-recovery
Operating Temperature	-20 ~ +50°C
Storage Temperature	-40 ~ +70°C
Relative Humidity	5 ~ 95%
Lifetime	50K hrs at TC max (85°C)
Connections	Screw terminal on I/P & O/P
Weight	200g
Dimensions (inches)	7.2" x 2.4" x 1.25"
Dimensions (cm)	18.4 cm x 6 cm x 3.2 cm

twentieth

sales@twentieth.net
323.904.1200
www.twentieth.net