



GABRIEL SCOTT

EST. 2012



**Welles by  
Alessandro Munge**  
Central Chandelier 12

in Blackened Steel & Opaque  
Smoked Black Glass

Alessandro Munge has developed a beautiful narrative infused with dynamic and bold fashion references inspired by rhythmic dance for his Welles capsule collection. The original Welles was deconstructed and rebuilt using a new support system and includes a beautiful jewel-like connecting bracket, thus creating a significant visual divergence and a reenergised dialogue between the interconnected elements.

While the fixture's volume is radically different to the original, the modular nature makes it a truly versatile and playful product, inviting designers to create bespoke configurations. The Welles Central Chandelier 12 brings an impressive sense of scale and structure, making it the perfect statement piece for a large space. Munge's capsule collection comprises a Central Chandelier in three different sizes, alongside an Arm Sconce.

twentieth

sales@twentieth.net  
323.904.1200  
www.twentieth.net

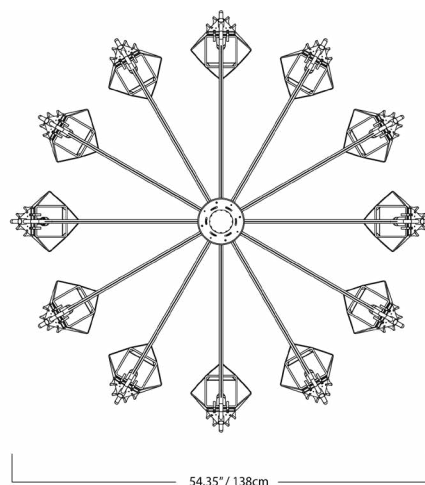
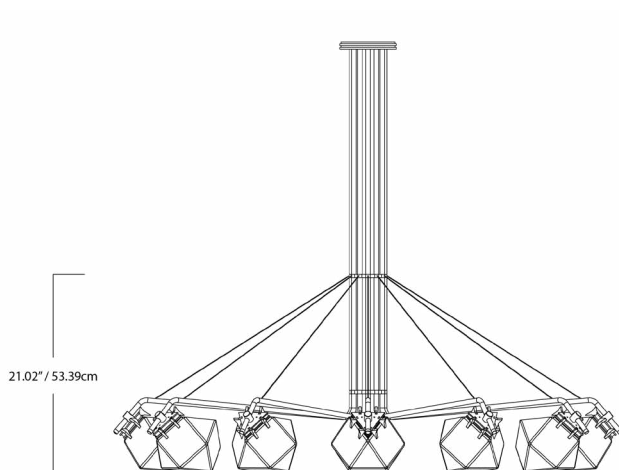

## SPECIFICATIONS

### Standard Finishes:

Blown Glass: Opaque Smoked Black

Metal: Blackened Steel

### Specifications:

Dimensions: 54.35" x 21.02" H + Stem

138 cm x 53.39 cm H + Stem

Weight: 95.75 lbs / 43.4 kg

Light Source: 12V 6 Watt LED (included)

LED Drivers: E60L12DC-KO - 110V  
UVC1250TD - 220V

Total Wattage (nominal): 37.2 w  
Lumens (total): 8160 lm

### Stems & Canopies:

Standard Stem Lengths: 6", 12", 18" or 24"

15 cm, 31 cm, 46 cm or 61 cm

Additional Stem Lengths: 30", 36", 42" or 48"

76 cm, 91 cm, 107 cm or 122 cm

(up-charge applies)

Standard Canopy: 6" x 0.75" / 15 cm x 1.9 cm

Deep Canopy: Available upon request.

Custom finishes available upon inquiry.

Made and assembled in Canada.

## STANDARD FINISHES

### Blown Glass:



Opaque Smoked Black

### Metal:

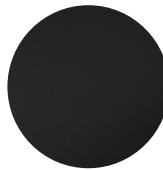

Blackened Steel

twentieth

sales@twentieth.net  
323.904.1200  
www.twentieth.net

# LED DRIVER

E60L12DC-KO - 110V

Magnitude's E60L12DC-KO dimmable voltage LED driver is class 2 rated and designed to operate with any standard MLV/ Incandescent TRIAC (Leading edge) dimmer switch. Encased in a low profile aluminum enclosure that includes 2 knock-outs to enable easy installation makes it the perfect choice for under cabinet lights, tape lights and various LED fixtures installations. Our electrical specification includes Auto Reset, over current and short circuit protection. Efficiency of 90% and higher allows the driver to operate at low temperatures.

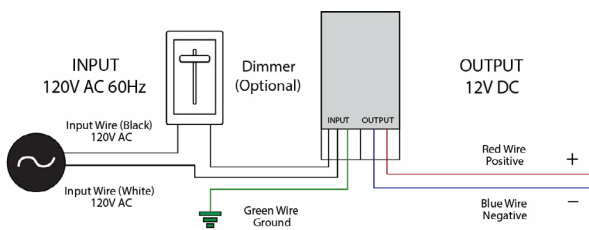
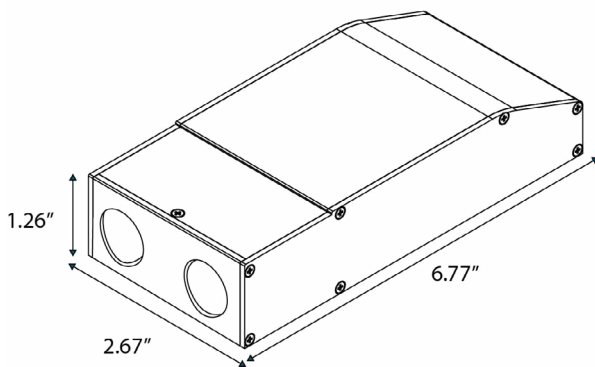

## Features:

- Dimmable with any standard MLV/Incandescent TRI-AC- (Leading edge) dimmer switch.
- Super compact ALUMINUM CASE.
- Class 2
- UL 8750
- IP67 - Withstands wet and salty conditions.
- Nema 3R - Outdoor Use
- Auto-Reset Protection for short circuits & over-voltage.
- FCC 15 part 2
- 12V DC True RMS

## Specifications:

Max Load	60W
Input Voltage	120V AC
Input Current at Max Load	0.61 A
Output Voltage	12V DC
Output Current at Max load	5.26 A
Power Factor	0.95
Efficiency	> 90 %
Operating Temp.	-20c - 70c (-4F -158F)
Short Circuit Protection	Yes
Overcurrent Protection	Yes
Over Temperature	Yes
Open Circuit Protections	Yes
Input Wires (White / Black)	14 AWG
Output Wires (Red / Black)	18 AWG
Weight	481g
Dimensions (inches)	6.77" x 2.67" x 1.26"
Dimensions (cm)	17.2 cm x 6.8 cm x 3.2 cm

twentieth

sales@twentieth.net  
323.904.1200  
www.twentieth.net

# LED DRIVER

UVC1250TD - 220V

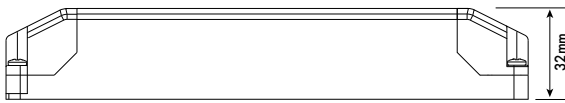
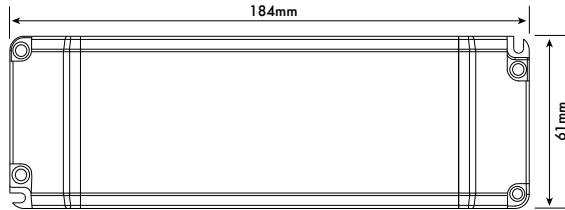

## Features:

- Constant voltage output
- Fully isolated
- Short circuit, over current and over voltage protection up to 80% efficient.
- Fire resistant plastic cover
- Compatible with leading and trailing edge dimmers
- 20 - 100% Dimming Load and Dimming range
- Mains dimmable
- Screw terminals
- IP44 design for indoor use
- 2 years warranty

## Specifications:

Part Code	UVC1250TD UVC2450TD
Voltage	220V ~ 240VAC
Frequency	50-60 Hz
Current	0.4A
Inrush Current	<2.5A
Power Factor	0.95
Load Voltage	12V
No Load Voltage	12V
Current	4.16A
Power	50W
Power Factor	>0.95
Efficiency (TYP)	>80%
Over Load	Auto-recovery
Short Circuit	Auto-recovery
Over Voltage	Auto-recovery
Operating Temperature	-20 ~ +50°C
Storage Temperature	-40 ~ +70°C
Relative Humidity	5 ~ 95%
Lifetime	50K hrs at TC max (85°C)
Connections	Screw terminal on I/P & O/P
Weight	200g
Dimensions (inches)	7.2" x 2.4" x 1.25"
Dimensions (cm)	18.4 cm x 6 cm x 3.2 cm

twentieth

sales@twentieth.net  
323.904.1200  
www.twentieth.net