

WELLES

Central chandelier 8 by Alessandro Munge

INSTALLATION GUIDE

GABRIEL SCOTT

twentieth

sales@twentieth.net
323.904.1200
www.twentieth.net

- Certified electrician recommended for electrical installation.
- Minimum 2 people recommended for installation.
- Terminal Block not included. Installation may require advice from a qualified person.
- Junction box rated for minimum of 260lbs or structural blocking required to support fixture.
- Structural blocking required at monopoint locations, adequate drywall plugs may be substituted.
- For all LED fixtures, use only with class 2 power unit.
- The light source contained in this luminaire shall only be replaced by the manufacturer or his service agent or a similar qualified person. Contact manufacturer for service.
- For controllable luminaires, the classification of insulation that has been maintained between LV supply and control conductors shall be provided: basic insulation, reinforced insulation etc.

PLEASE READ THIS BEFORE INSTALLATION:

IMPORTANT: Please provide email confirmation that your order and its related components have been received in their entirety and in good condition. Failure to do so within 7 days of delivery will waive all product warranties.

+1 (212) 837-2923
support@gabriel-scott.com



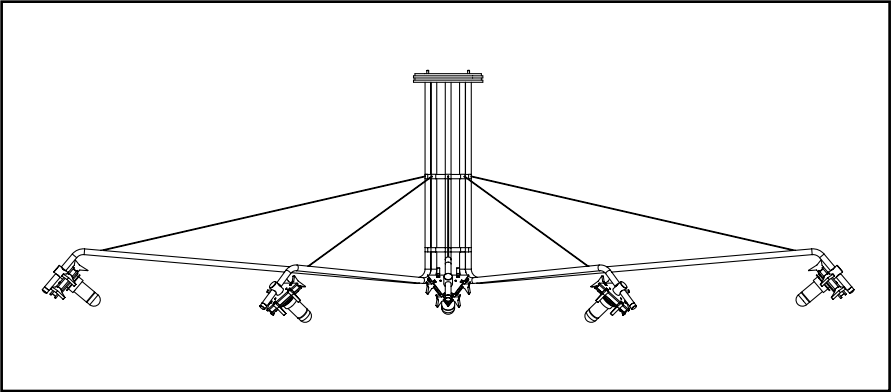

FILE#: E488971
FILE#: E503097

FIXTURE

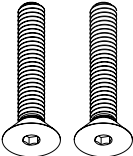
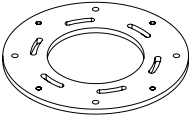
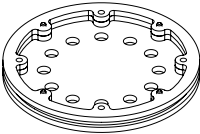
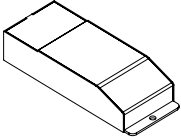

ALSO SHIPPED

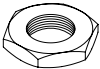
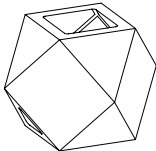
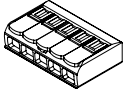
			
#8-32 screws 4x	Cross bar 1x	Canopy 1x	Led driver 1x
			
Stems 8x	Hex nuts 8x	Glass volumes 8x	Splicing connectors 6x

01.

Cut power and remove existing junction box.

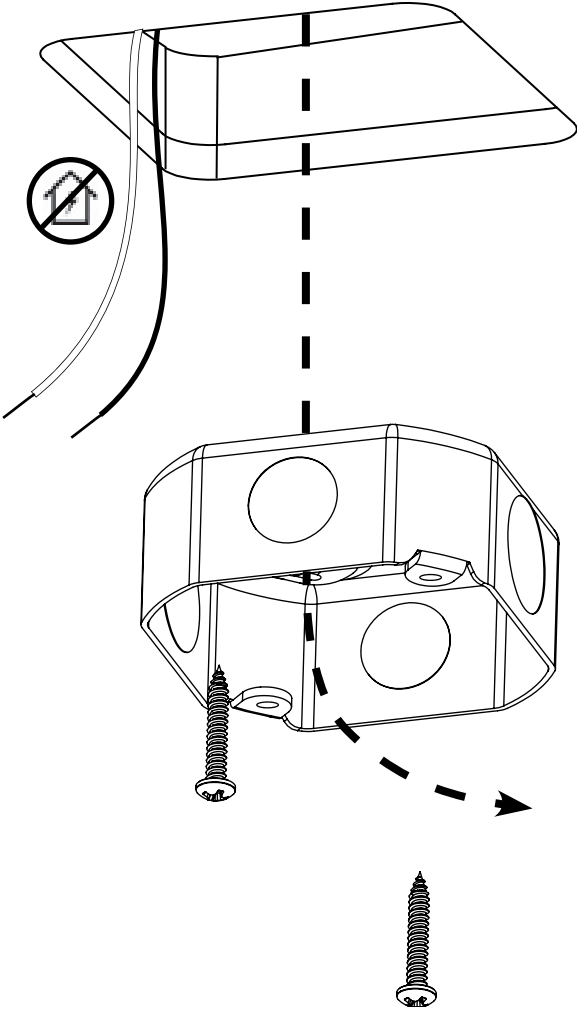

02.

Using wire terminals, connect the LED driver to the main power source. Secure the LED driver in remote location by also making sure to keep access to the output wires. Install the driver within 100ft of the fixture. Refer to the driver documentation for more informations.

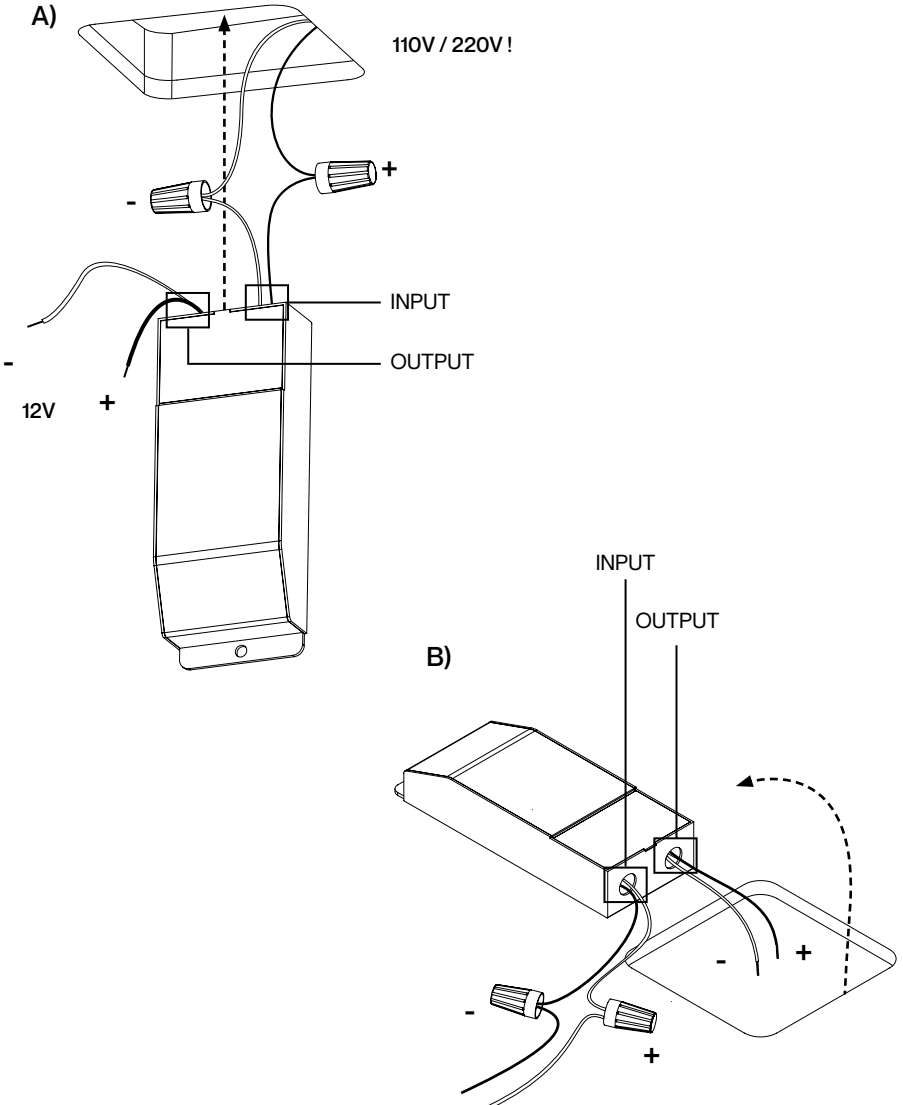



03.

Insert the junction box back in the ceiling hole. Install the cross bar to the ceiling with the appropriate screws.

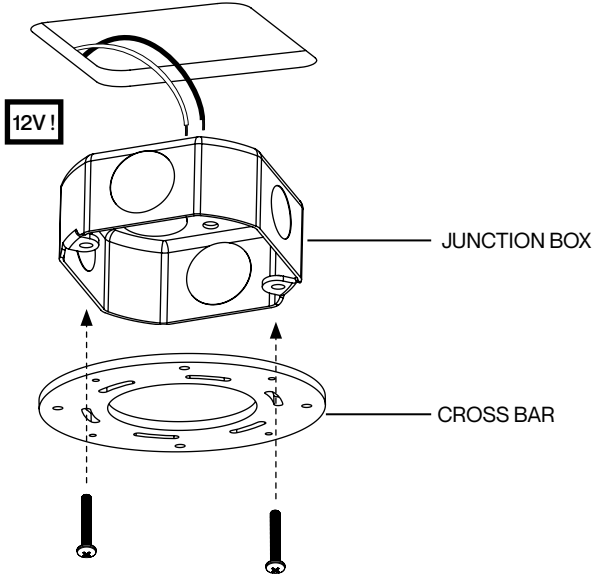

Ceiling Elevation

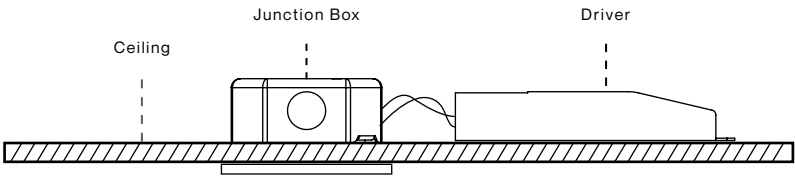

04.

Remove the protection brackets from the top of the fixture.

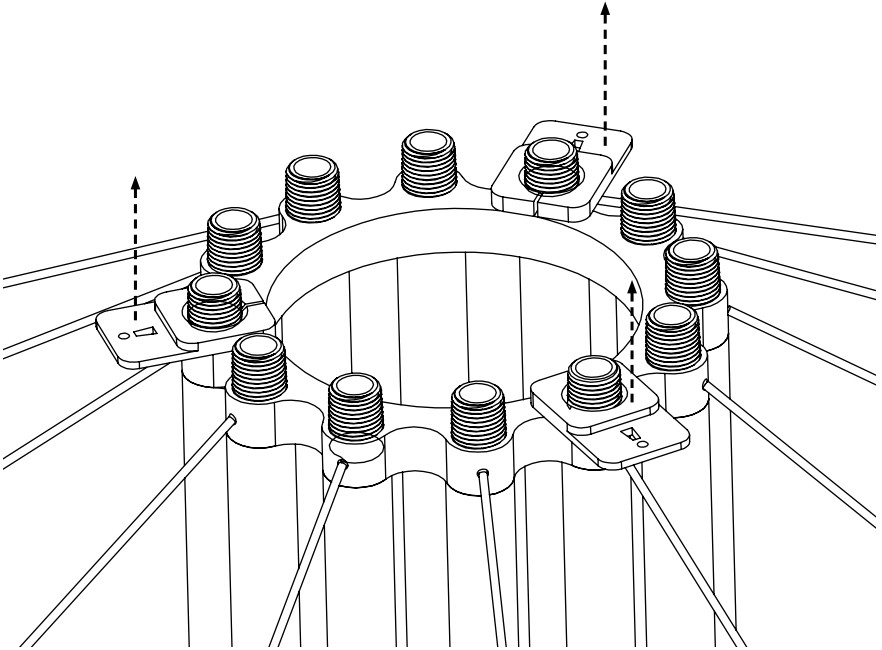



05.

Fix the stems on top of the fixture while making sure every power cables are passing trough.

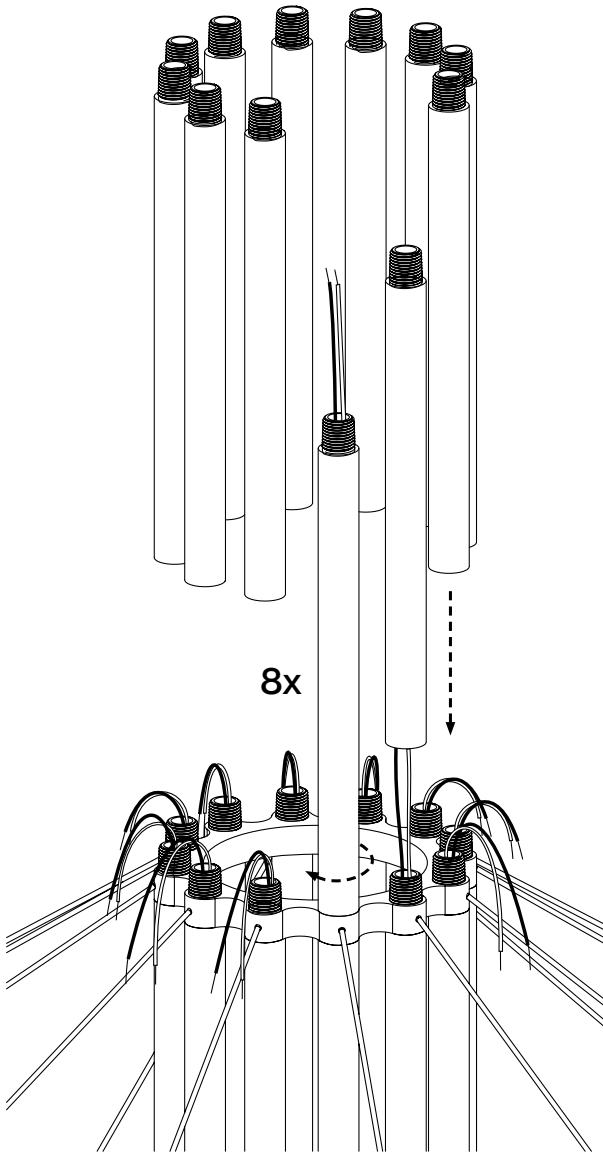



06.

Insert the canopy on top of the stems and lock it in place using the provided hex nuts.

A)

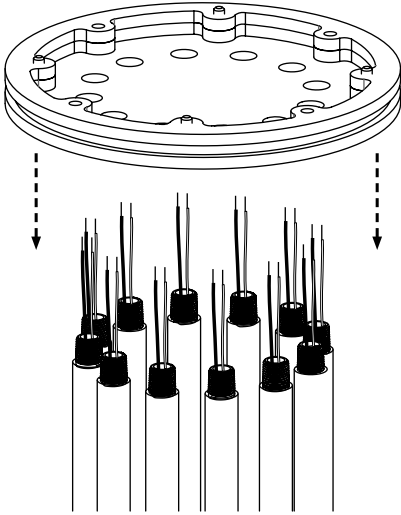

B)

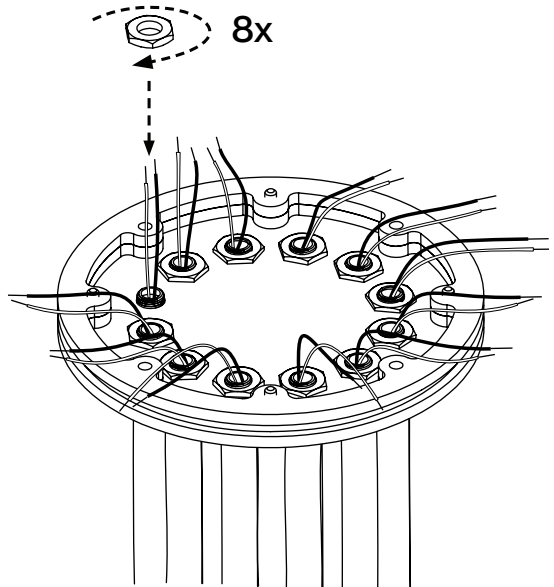

07.

Split positive and negative cables in two separate groups using the provided connectors.

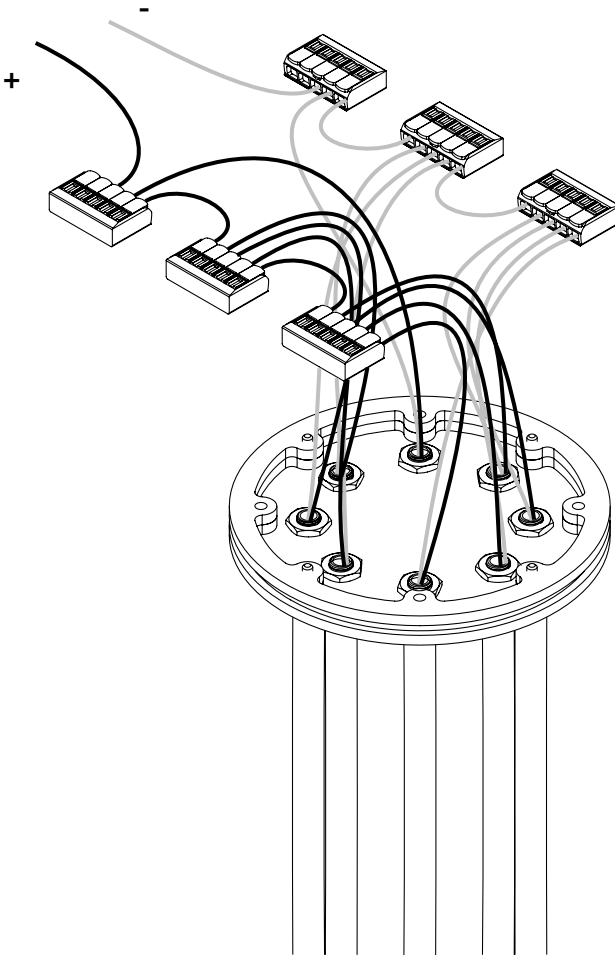



08.

Wire the chandelier to the LED driver.

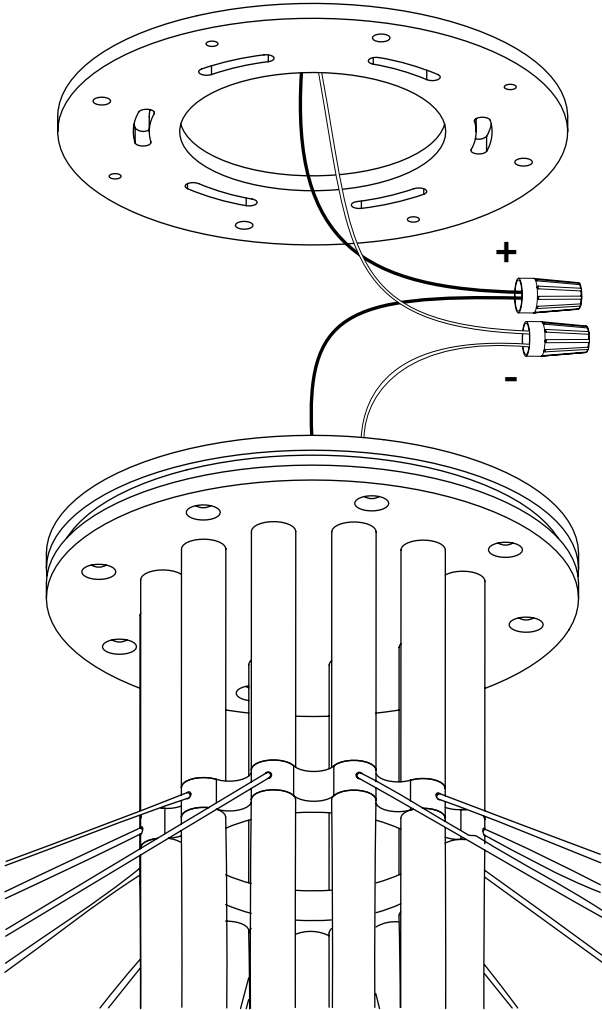



09.

Attach the chandelier to the cross bar using the provided screws.

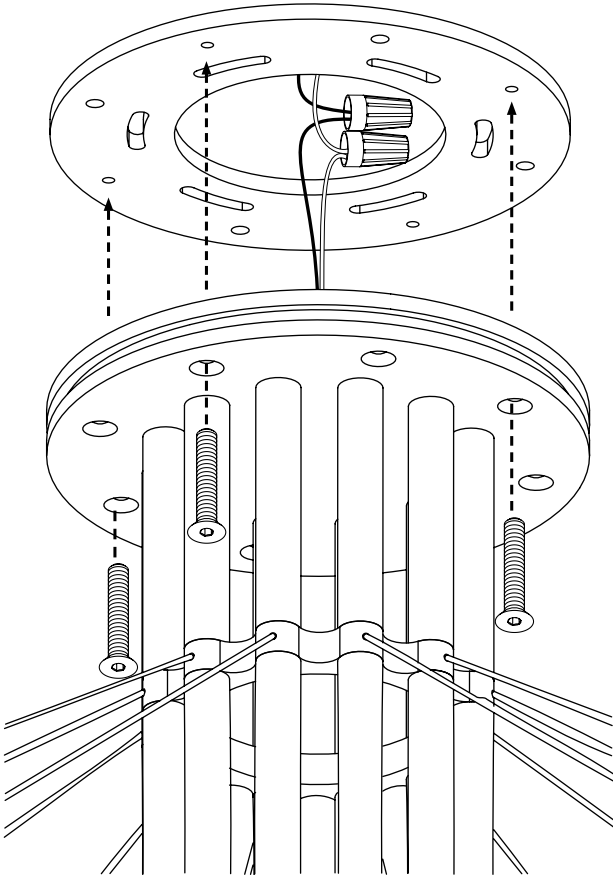

10.

Install the glass globes by unscrewing the retaining rings and carefully slide the globes in place. Screw back the retaining rings firmly.

A)

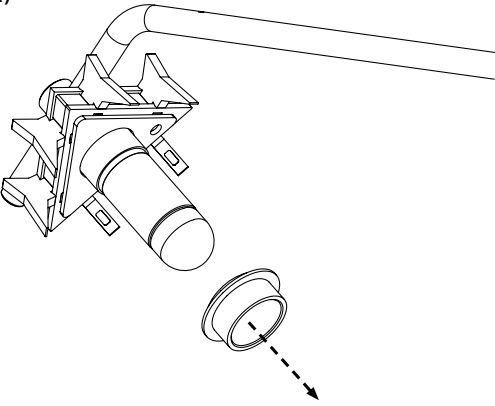

B)

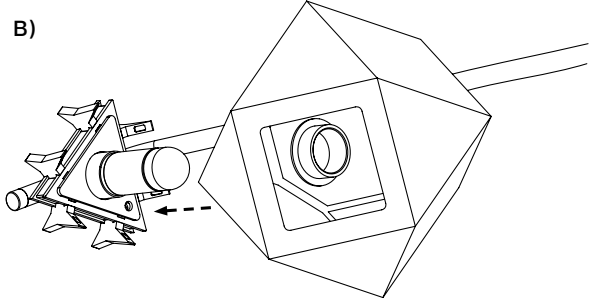

C)

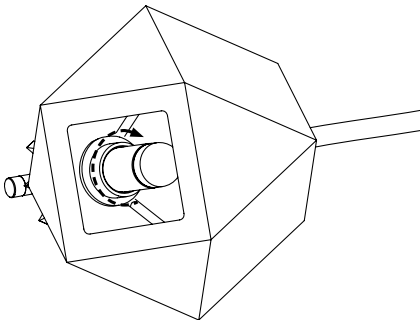

11.

Level the fixture's arms by adjusting the griplock situated on top of each light assembly. Cut the excess cable and screw the cap on the nipple.

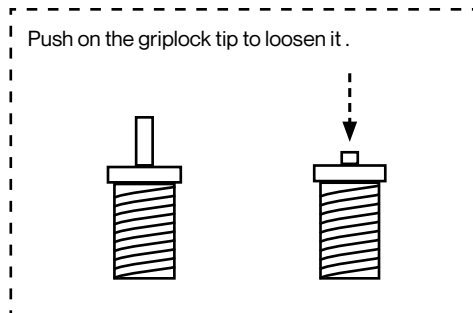
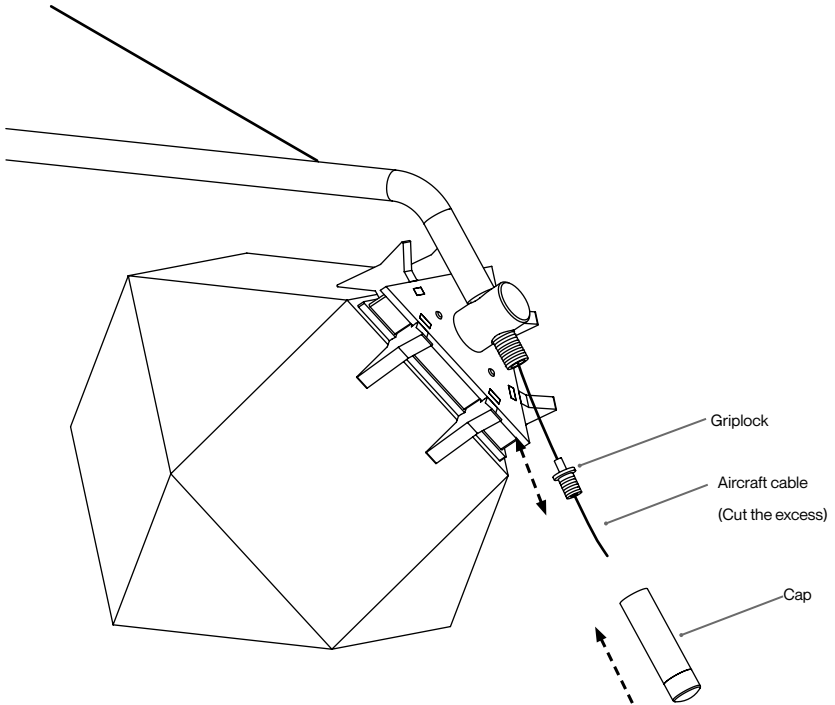

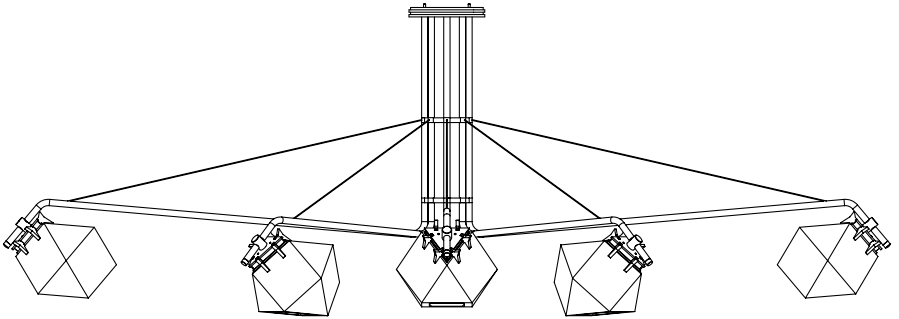

**You have successfully installed your
Welles Munge chandelier!**

For other questions, please consult our website:
www.gabriel-scott.com