

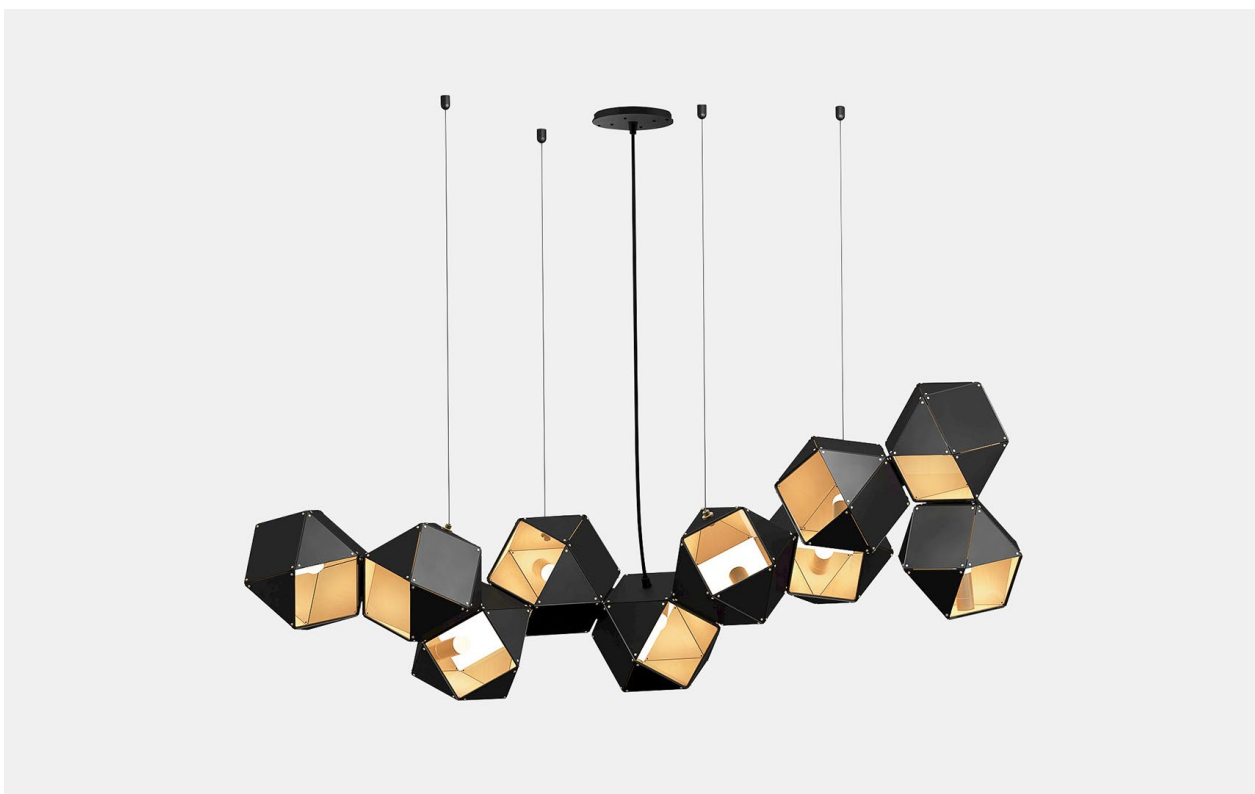

GABRIEL SCOTT

EST. 2012



**WELLES**  
**Steel Long**  
**Chandelier 10**  
in Blackened Steel  
& Satin Brass

A fixture of metallic proportion, Gabriel Scott's signature Welles is a modern piece that showcases expert artistry. Hollowed metallic polygons branch out into a modular system of interconnected configurations for a stunning optical illusion. With its endless possibilities, the Welles floats in the air emitting a cloud of soft light through its multifaceted, sculpturally innovative silhouette.

The Welles is scaled to various shapes and sizes and can be assembled to horizontal, vertical, or diametric applications. The Welles has been developed to be highly customizable. Allow our in-house design team to assist in creating the perfect silhouette to match your project's needs. Available in black or white steel, satin brass, satin copper, or satin nickel.

All Gabriel Scott pieces are handmade in Canada.

twentieth

sales@twentieth.net  
323.904.1200  
www.twentieth.net

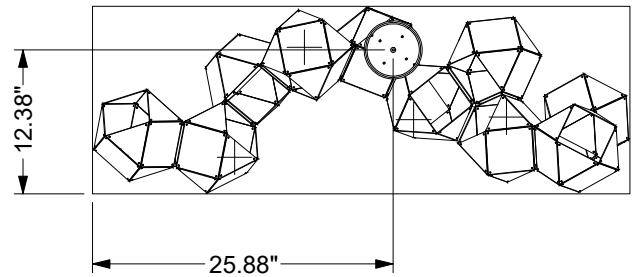
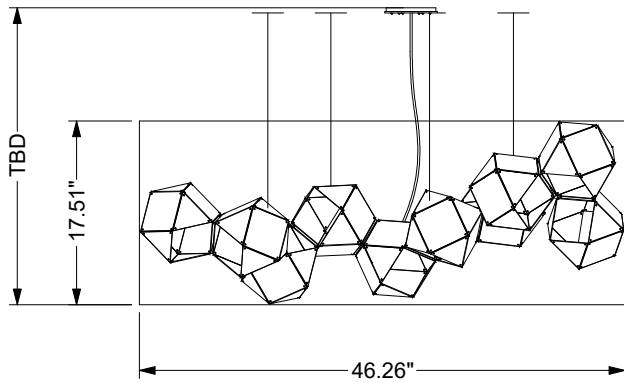

## SPECIFICATIONS

### Standard Finishes:

Metal: Blackened Steel, White Steel, Satin Nickel, Satin Brass or Satin Copper

### Specifications:

Dimensions: 46.26" x 16" x 17.51" H + Drop

117 cm x 41 cm x 46 cm + Drop

Weight: 3 lbs / 1.36 kg per cube

Light Source: 12V 3 Watt LED (included)

LED Drivers: E60L12DC-KO - 110V  
UVC1250TD - 220V

Total Wattage (nominal): 31 w

Lumens (total): 6800 lm

### Cables & Canopies:

Cable Length: 96" / 244 cm Drop, adjustable upon installation

(increased cable-lengths available upon request)

Standard Canopy: 5" x 0.5" / 12 cm x 1.3 cm

Deep Canopy: Dimensions on request.

Custom finishes available upon inquiry.

Made and assembled in Canada. Item is UL & CE listed.



## STANDARD FINISHES

### Metal Finishes:



White Steel & Satin Brass

White Steel & Satin Copper

White Steel & Satin Nickel

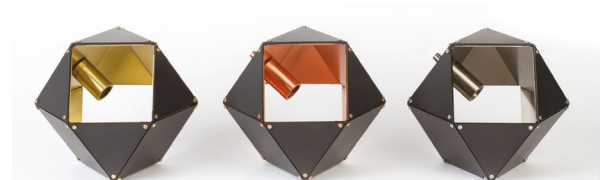

Blackened Steel & Satin Brass

Blackened Steel & Satin Copper

Blackened Steel & Satin Nickel



Satin Brass

Satin Copper

Satin Nickel

twentieth

sales@twentieth.net  
323.904.1200  
www.twentieth.net

# LED DRIVER

E60L12DC-KO - 110V

Magnitude's E60L12DC-KO dimmable voltage LED driver is class 2 rated and designed to operate with any standard MLV/ Incandescent TRIAC (Leading edge) dimmer switch. Encased in a low profile aluminum enclosure that includes 2 knock-outs to enable easy installation makes it the perfect choice for under cabinet lights, tape lights and various LED fixtures installations. Our electrical specification includes Auto Reset, over current and short circuit protection. Efficiency of 90% and higher allows the driver to operate at low temperatures.

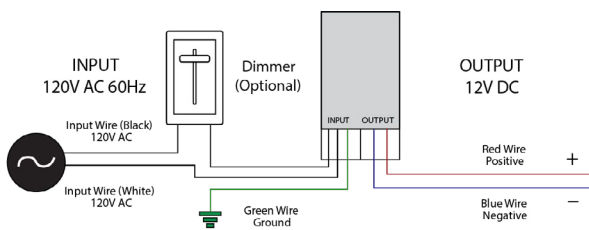
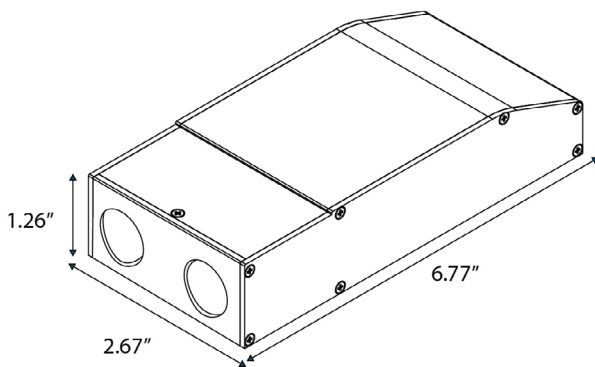

## Features:

- Dimmable with any standard MLV/Incandescent TRI-AC- (Leading edge) dimmer switch.
- Super compact ALUMINUM CASE.
- Class 2
- UL 8750
- IP67 - Withstands wet and salty conditions.
- Nema 3R - Outdoor Use
- Auto-Reset Protection for short circuits & over-voltage.
- FCC 15 part 2
- 12V DC True RMS

## Specifications:

Max Load	60W
Input Voltage	120V AC
Input Current at Max Load	0.61 A
Output Voltage	12V DC
Output Current at Max load	5.26 A
Power Factor	0.95
Efficiency	> 90 %
Operating Temp.	-20c - 70c (-4F -158F)
Short Circuit Protection	Yes
Overcurrent Protection	Yes
Over Temperature	Yes
Open Circuit Protections	Yes
Input Wires (White / Black)	14 AWG
Output Wires (Red / Black)	18 AWG
Weight	481g
Dimensions (inches)	6.77" x 2.67" x 1.26"
Dimensions (cm)	17.2 cm x 6.8 cm x 3.2 cm

twentieth

sales@twentieth.net  
323.904.1200  
www.twentieth.net

# LED DRIVER

UVC1250TD - 220V

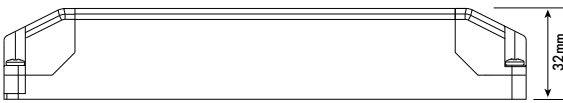
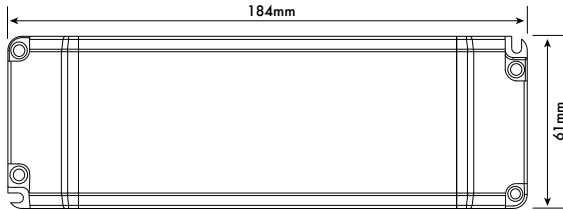

## Features:

- Constant voltage output
- Fully isolated
- Short circuit, over current and over voltage protection up to 80% efficient.
- Fire resistant plastic cover
- Compatible with leading and trailing edge dimmers
- 20 - 100% Dimming Load and Dimming range
- Mains dimmable
- Screw terminals
- IP44 design for indoor use
- 2 years warranty

## Specifications:

Part Code	UVC1250TD UVC2450TD
Voltage	220V ~ 240VAC
Frequency	50-60 Hz
Current	0.4A
Inrush Current	<2.5A
Power Factor	0.95
Load Voltage	12V
No Load Voltage	12V
Current	4.16A
Power	50W
Power Factor	>0.95
Efficiency (TYP)	>80%
Over Load	Auto-recovery
Short Circuit	Auto-recovery
Over Voltage	Auto-recovery
Operating Temperature	-20 ~ +50°C
Storage Temperature	-40 ~ +70°C
Relative Humidity	5 ~ 95%
Lifetime	50K hrs at TC max (85°C)
Connections	Screw terminal on I/P & O/P
Weight	200g
Dimensions (inches)	7.2" x 2.4" x 1.25"
Dimensions (cm)	18.4 cm x 6 cm x 3.2 cm

twentieth

sales@twentieth.net  
323.904.1200  
www.twentieth.net